

1 2 3 4 5 6

A

B

C

D

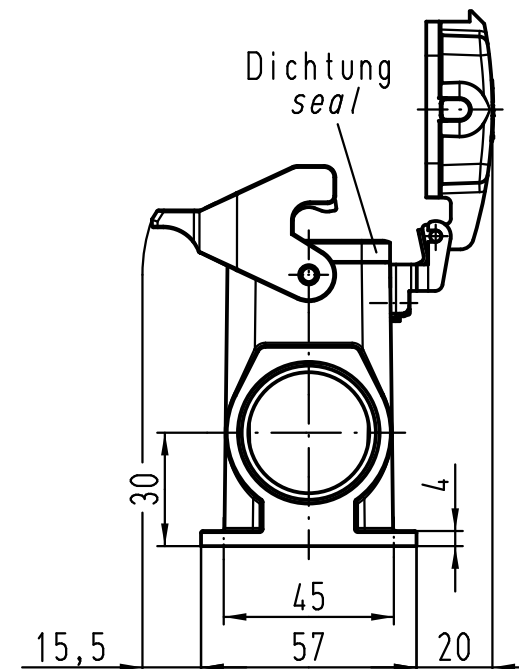
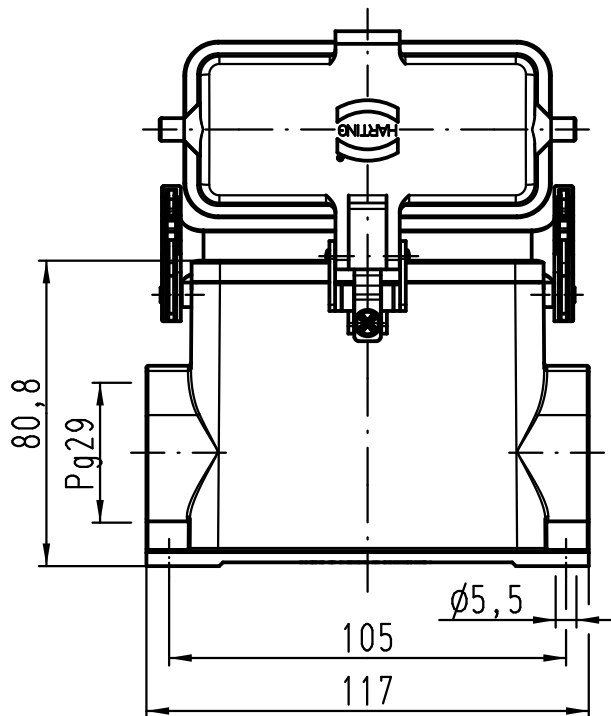
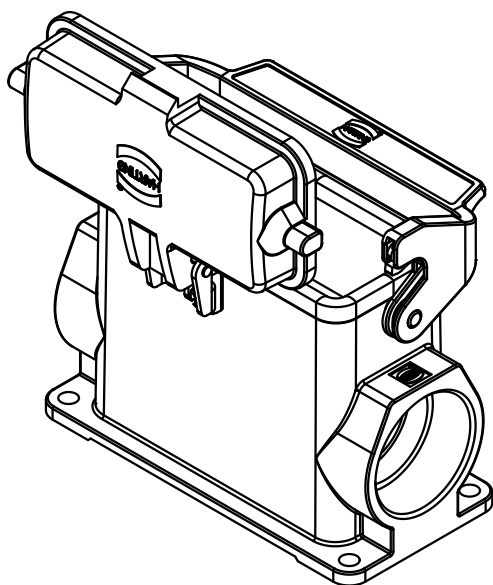

All Dimensions in mm Original Size DIN A 4		Techn. Character.			Nicht tolerierte Maße! Free size tolerances	
			Dat.	Name	Maßstab/Scale 1:2	Han 16B-asg1-LB-K-29 Sockelgehäuse housings surface mounting
		Detail.	30.05.11	Ho		
		Insp.		Be		
		Stand.				
A			HARTING Electric GmbH & Co. KG D-32339 Espelkamp			TB 09 30 016 0256
Mod.	Dat.	Name				
						Blatt/page