

## Peak Emission Wavelength: 765nm

The MTE2077N1-R is a red T 1 3/4, 5mm water clear emitter designed for applications requiring high power output and high reliability in a narrow angle package.

### FEATURES

- > High Reliability
- > Narrow Beam Angle
- > High Output Power

### APPLICATIONS

- > Optical Sensors
- > Optical Switches
- > Medical Application

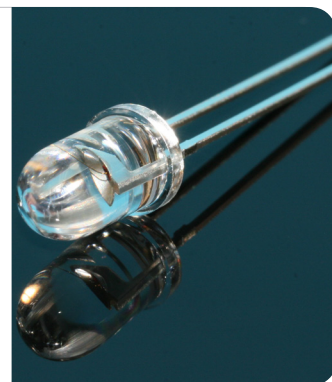

## Absolute Maximum Ratings (Ta=25°C)



| ITEMS                        | SYMBOL | RATINGS    | UNIT |
|------------------------------|--------|------------|------|
| Forward Current (DC)         | IF     | 50         | mA   |
| Forward Current (Pulse)*1    | IFP    | 0.5        | A    |
| Reverse Voltage              | VR     | 5          | V    |
| Power Dissipation            | PD     | 100        | mW   |
| Operating Temperature Range  | Topr   | -20 ~ +80  | °C   |
| Storage Temperature Range    | Tstg   | -30 ~ +100 | °C   |
| Junction Temperature         | Tj     | 100        | °C   |
| Lead Soldering Temperature*2 | Tls    | 260        | °C   |

\*1: Tw=10μsec, T=10msec; \*2: Time 5 Sec max, Position: Up to 3mm from the body.

## Electrical & Optical Characteristics (Ta = 25°C)

| ITEMS                     | SYMBOL | CONDITIONS | MIN | TYP  | MAX  | UNIT |
|---------------------------|--------|------------|-----|------|------|------|
| Power Output              | PO     | IF=20mA    | --  | 8.0  | --   | mW   |
| Forward Voltage           | VF     | IF=20mA    | --  | 1.55 | 1.90 | V    |
| Reverse Current           | IR     | VR=5V      | --  | --   | 100  | μA   |
| Peak Emission Wavelength  | λp     | IF=20mA    | --  | 765  | --   | nm   |
| Spectral Line Half Width  | Δλ     | IF=20mA    | --  | 35   | --   | nm   |
| Half Intensity Beam Angle | Θ      | IF=20mA    | --  | ±8   | --   | deg  |

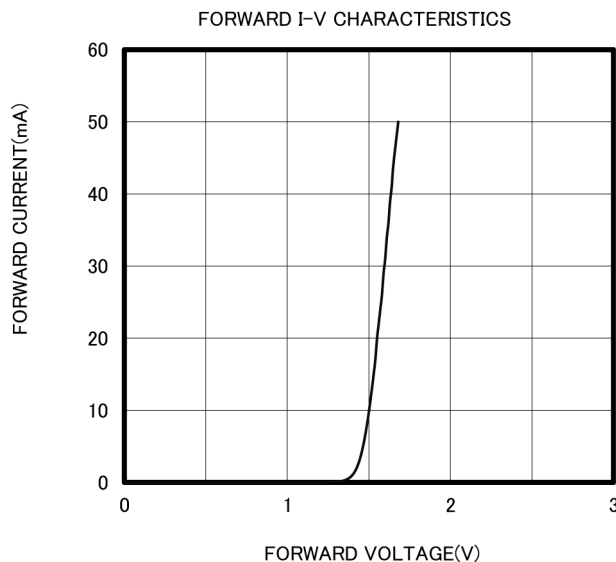
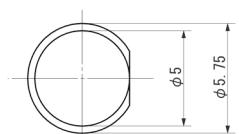
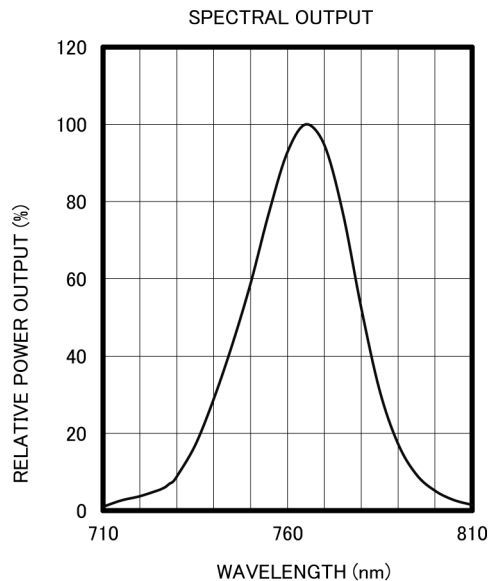
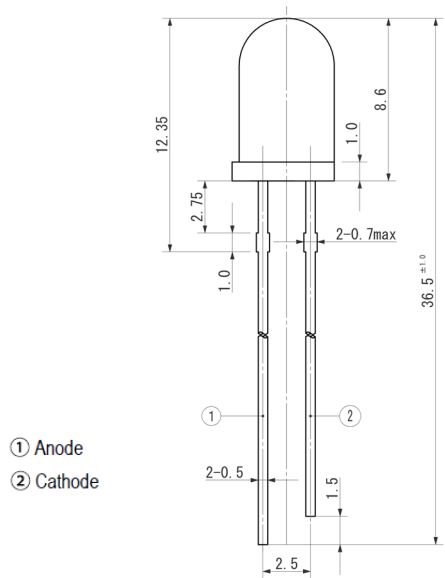

Unit: mm, Tolerance:  $\pm 0.2$

RELATIVE POWER vs FORWARD CURRENT

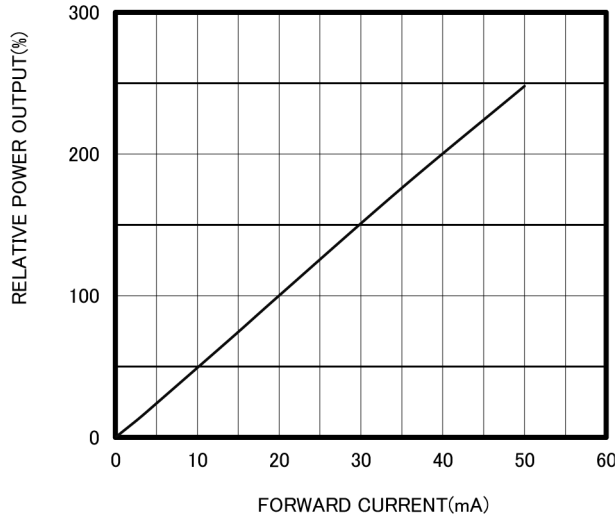

THERMAL DERATING CURVE

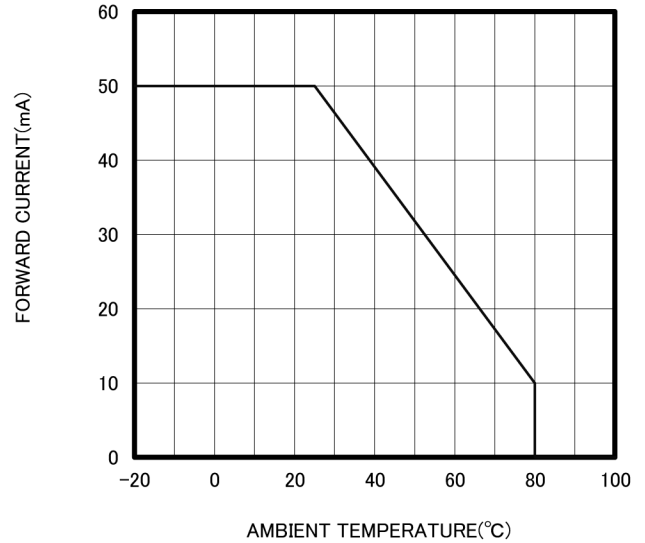

RADIATION PATTERN

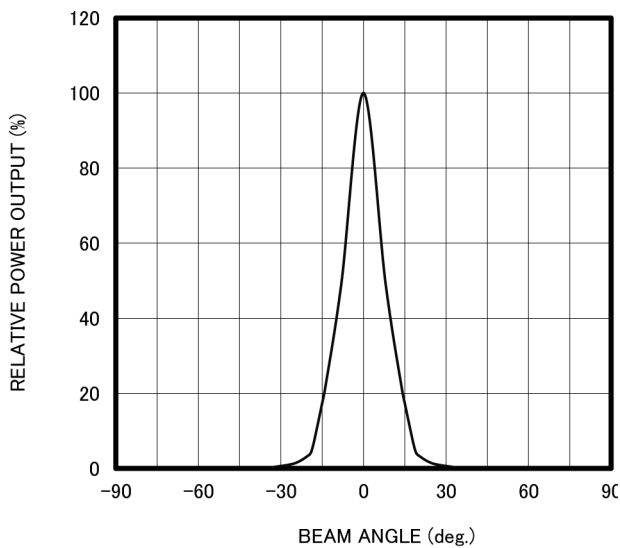

The information contained herein is subject to change without notice.

2012-10-17