

Product Summary

Device	V _{(BR)DSS}	R _{DS(ON)} max	I _D max T _A = +25°C
Q1	60V	85mΩ @ V _{GS} = 10V	3.1A
		120mΩ @ V _{GS} = 4.5V	2.7A
Q2	-60V	150mΩ @ V _{GS} = -10V	-2.4A
		250mΩ @ V _{GS} = -4.5V	-1.8A

Description

This new generation MOSFET is designed to minimize the on-state resistance (R_{DS(ON)}), yet maintain superior switching performance, making it ideal for high efficiency power management applications.

Applications

- Power Management Functions
- Analog Switch

Features

- Low On-Resistance
- Low Input Capacitance
- Fast Switching Speed
- Low Input/Output Leakage
- Complementary Pair MOSFET
- **Totally Lead-Free & Fully RoHS Compliant (Notes 1 & 2)**
- **Halogen and Antimony Free. "Green" Device (Note 3)**

Mechanical Data

- Case: POWERDI®3333-8
- Case Material: Molded Plastic, "Green" Molding Compound.
- UL Flammability Classification Rating 94V-0
- Moisture Sensitivity: Level 1 per J-STD-020
- Terminals: Finish – Matte Tin Annealed over Copper Leadframe; Solderable per MIL-STD-202, Method 208③
- Weight: 0.072 grams (Approximate)

POWERDI3333-8

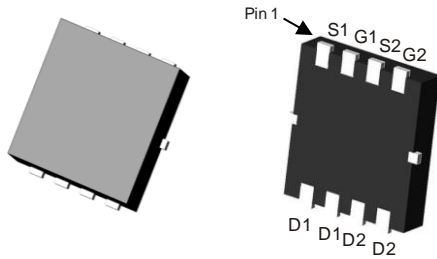

Top View

Bottom View

Equivalent Circuit

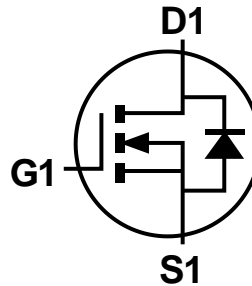

N-Channel MOSFET

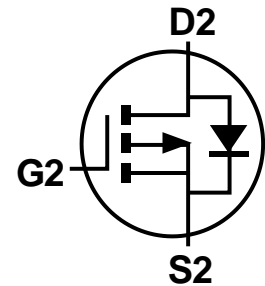

P-Channel MOSFET

Ordering Information (Note 4)

Part Number	Case	Packaging
DMC6070LND-7	POWERDI3333-8	2,000/Tape & Reel
DMC6070LND-13	POWERDI3333-8	3,000/Tape & Reel

- Notes:
1. No purposely added lead. Fully EU Directive 2002/95/EC (RoHS) & 2011/65/EU (RoHS 2) compliant.
 2. See http://www.diodes.com/quality/lead_free.html for more information about Diodes Incorporated's definitions of Halogen- and Antimony-free, "Green" and Lead-free.
 3. Halogen- and Antimony-free "Green" products are defined as those which contain <900ppm bromine, <900ppm chlorine (<1500ppm total Br + Cl) and <1000ppm antimony compounds.
 4. For packaging details, go to our website at <http://www.diodes.com/products/packages.html>.

Marking Information

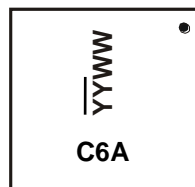

C6A = Product Type Marking Code
 YYWW = Date Code Marking
 YY = Last Two Digits of Year (ex: 15 for 2015)
 WW = Week Code (01 to 53)

Maximum Ratings Q1 N-CHANNEL (@ $T_A = +25^\circ\text{C}$, unless otherwise specified.)

Characteristic			Symbol	Value	Unit
Drain-Source Voltage			V_{DSS}	60	V
Gate-Source Voltage			V_{GSS}	± 20	V
Continuous Drain Current (Note 5) $V_{GS} = 10\text{V}$	Steady State	$T_A = +25^\circ\text{C}$ $T_A = +70^\circ\text{C}$	I_D	3.1 2.5	A
	$t < 10\text{s}$	$T_A = +25^\circ\text{C}$ $T_A = +70^\circ\text{C}$	I_D	3.9 3.1	A
Maximum Body Diode Forward Current (Note 5)			I_S	2	A
Pulsed Drain Current (10 μs Pulse, Duty Cycle = 1%)			I_{DM}	15	A

Maximum Ratings Q2 P-CHANNEL (@ $T_A = +25^\circ\text{C}$, unless otherwise specified.)

Characteristic			Symbol	Value	Unit
Drain-Source Voltage			V_{DSS}	-60	V
Gate-Source Voltage			V_{GSS}	± 20	V
Continuous Drain Current (Note 5) $V_{GS} = -10\text{V}$	Steady State	$T_A = +25^\circ\text{C}$ $T_A = +70^\circ\text{C}$	I_D	-2.4 -1.9	A
	$t < 10\text{s}$	$T_A = +25^\circ\text{C}$ $T_A = +70^\circ\text{C}$	I_D	-2.9 -2.3	A
Maximum Body Diode Forward Current (Note 5)			I_S	-2	A
Pulsed Drain Current (10 μs Pulse, Duty Cycle = 1%)			I_{DM}	-12	A

Thermal Characteristics (@ $T_A = +25^\circ\text{C}$, unless otherwise specified.)

Characteristic		Symbol	Value	Unit
Total Power Dissipation (Note 5)		P_D	1.4	W
Thermal Resistance, Junction to Ambient (Note 5)	Steady state	$R_{\theta JA}$	91	$^\circ\text{C/W}$
	$t < 10\text{s}$		60	
Thermal Resistance, Junction to Case (Note 5)		$R_{\theta JC}$	32	
Operating and Storage Temperature Range		T_J, T_{STG}	-55 to +150	$^\circ\text{C}$

Note: 5. Device mounted on FR-4 substrate PC board, 2oz copper, with thermal bias to bottom layer 1inch square copper plate.

Electrical Characteristics Q1 N-CHANNEL (@T_A = +25°C, unless otherwise specified.)

Characteristic	Symbol	Min	Typ	Max	Unit	Test Condition
OFF CHARACTERISTICS (Note 6)						
Drain-Source Breakdown Voltage	BV _{DSS}	60	–	–	V	V _{GS} = 0V, I _D = 250μA
Zero Gate Voltage Drain Current T _J = +25°C	I _{DSS}	–	–	1	μA	V _{DS} = 60V, V _{GS} = 0V
Gate-Source Leakage	I _{GSS}	–	–	±100	nA	V _{GS} = ±16V, V _{DS} = 0V
ON CHARACTERISTICS (Note 6)						
Gate Threshold Voltage	V _{GS(TH)}	1	–	3	V	V _{DS} = V _{GS} , I _D = 250μA
Static Drain-Source On-Resistance	R _{DS(ON)}	–	60	85	mΩ	V _{GS} = 10V, I _D = 1.5A
			72	120		V _{GS} = 4.5V, I _D = 0.5A
Forward Transfer Admittance	Y _{fs}	–	3.7	–	S	V _{DS} = 5V, I _D = 1.5A
Diode Forward Voltage	V _{SD}	–	0.7	1.2	V	V _{GS} = 0V, I _S = 3A
DYNAMIC CHARACTERISTICS (Note 7)						
Input Capacitance	C _{iss}	–	731	–	pF	V _{DS} = 20V, V _{GS} = 0V, f = 1MHz
Output Capacitance	C _{oss}	–	34	–	pF	
Reverse Transfer Capacitance	C _{rss}	–	23	–	pF	
Gate Resistance	R _g	–	1.3	–	Ω	V _{DS} = 0V, V _{GS} = 0V, f = 1MHz
Total Gate Charge (V _{GS} = 10V)	Q _g	–	11.5	–	nC	V _{DS} = 30V, I _D = 3A
Total Gate Charge (V _{GS} = 4.5V)	Q _g	–	5.2	–	nC	
Gate-Source Charge	Q _{gs}	–	2.1	–	nC	
Gate-Drain Charge	Q _{gd}	–	1.5	–	nC	
Turn-On Delay Time	t _{D(ON)}	–	9.6	–	ns	V _{GS} = 10V, V _{DS} = 30V, R _G = 50Ω, R _L = 20Ω
Turn-On Rise Time	t _R	–	11	–	ns	
Turn-Off Delay Time	t _{D(OFF)}	–	61	–	ns	
Turn-Off Fall Time	t _F	–	21	–	ns	

Notes: 6. Short duration pulse test used to minimize self-heating effect.
7. Guaranteed by design. Not subject to production testing.

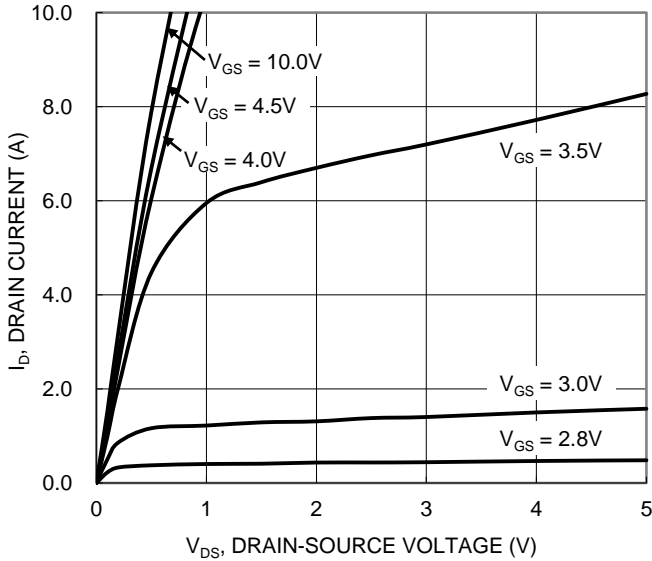

Figure 1. Typical Output Characteristic

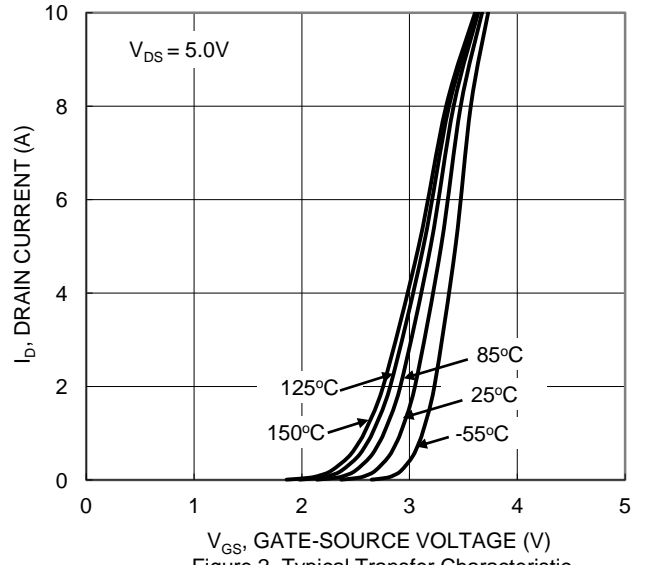

Figure 2. Typical Transfer Characteristic

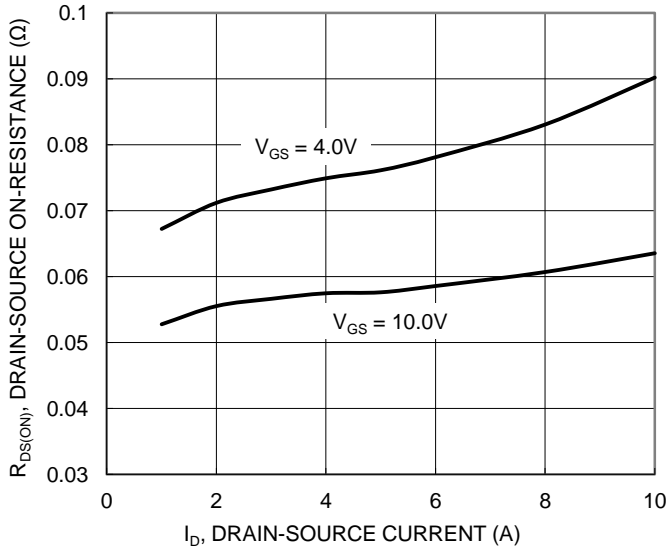

Figure 3. Typical On-Resistance vs. Drain Current and Gate Voltage

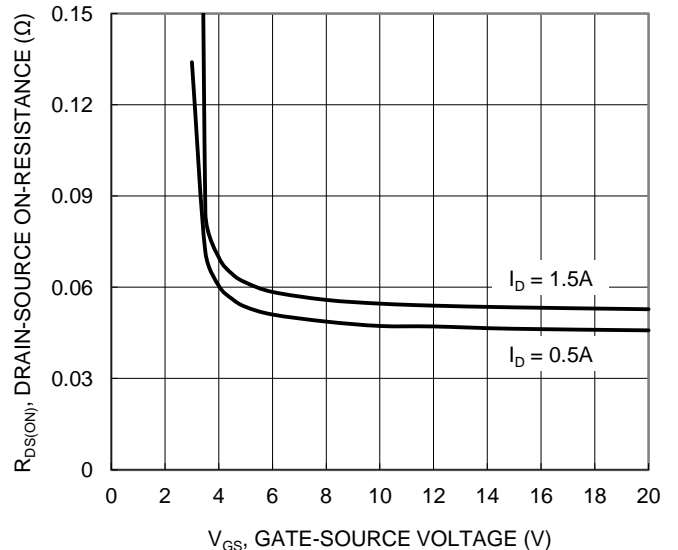

Figure 4. Typical Transfer Characteristic

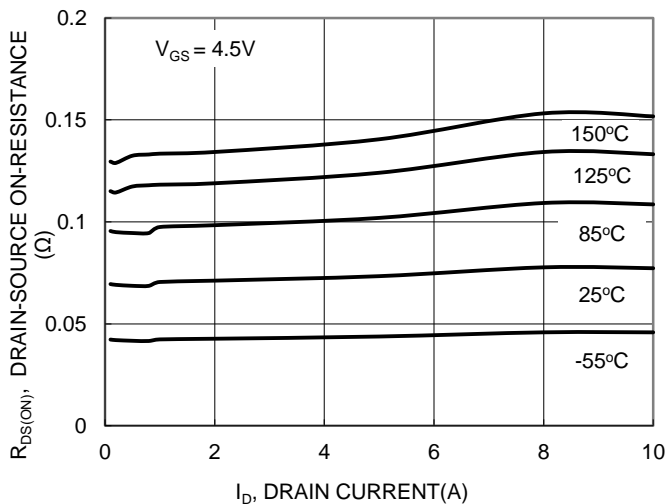

Figure 5. Typical On-Resistance vs. Drain Current and Temperature

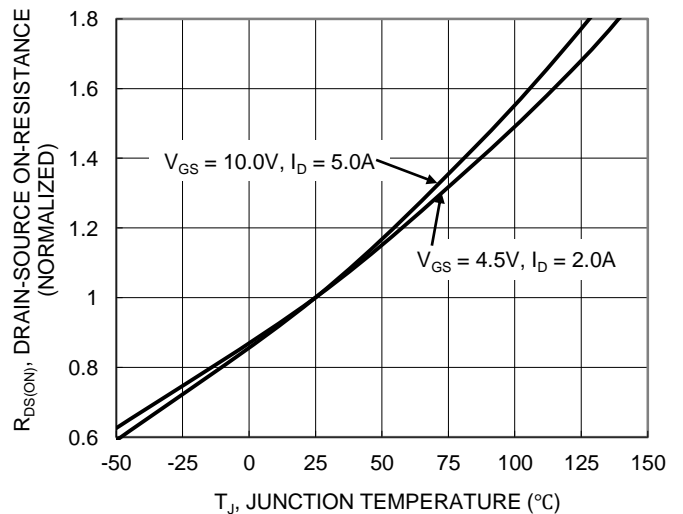

Figure 6. On-Resistance Variation with Temperature

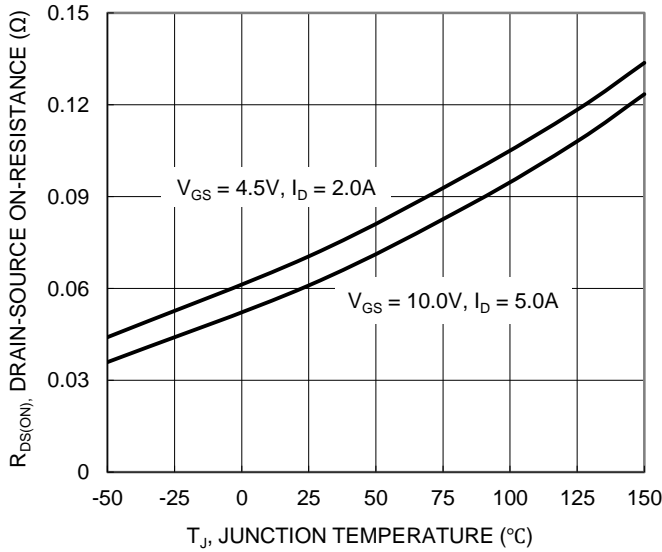

Figure 7. On-Resistance Variation with Temperature

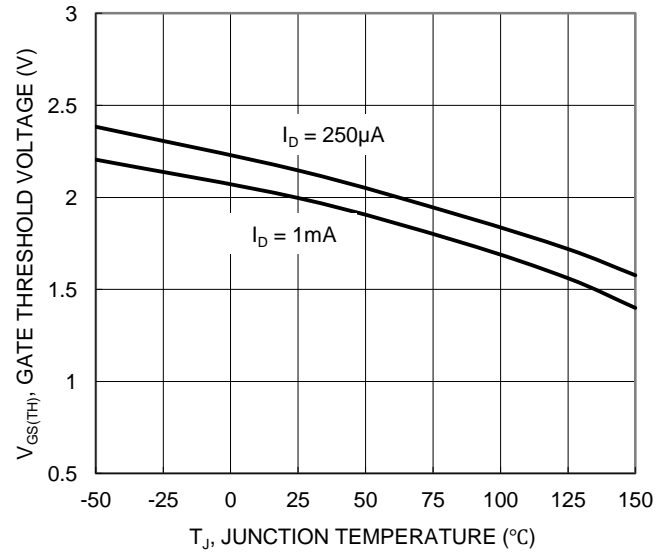

Figure 8. Gate Threshold Variation vs. Junction Temperature

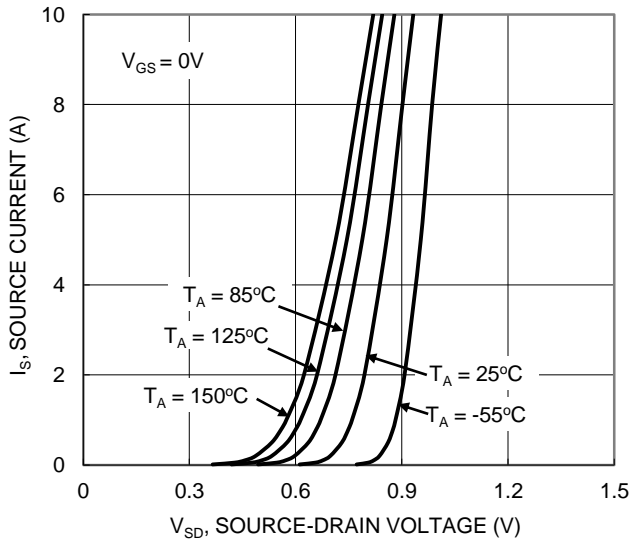

Figure 9. Diode Forward Voltage vs. Current

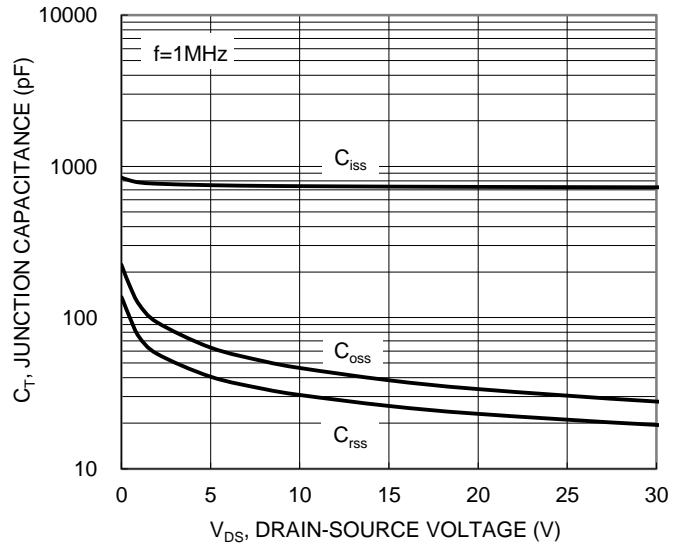

Figure 10. Typical Junction Capacitance

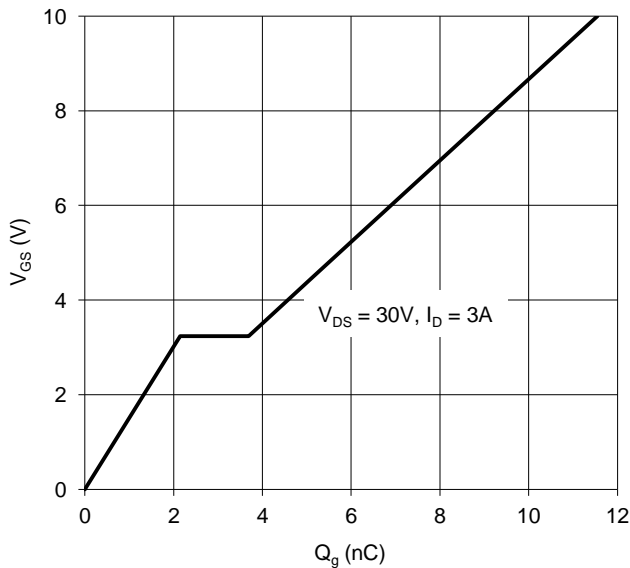

Figure 11. Gate Charge

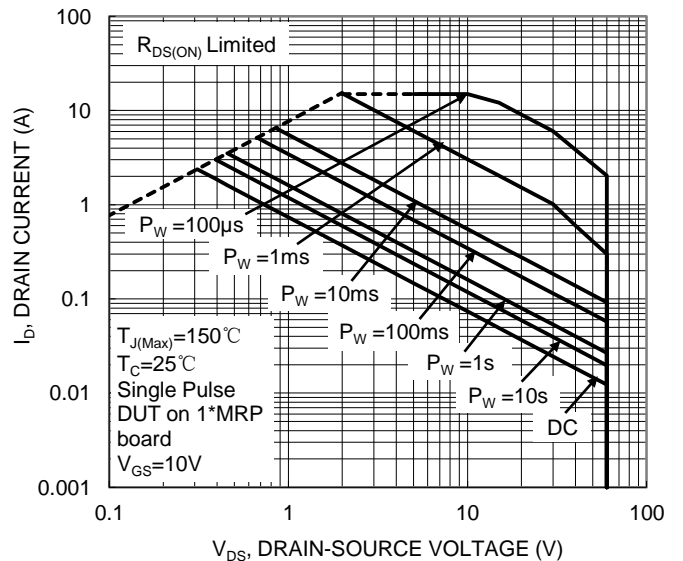

Figure 12. SOA, Safe Operation Area

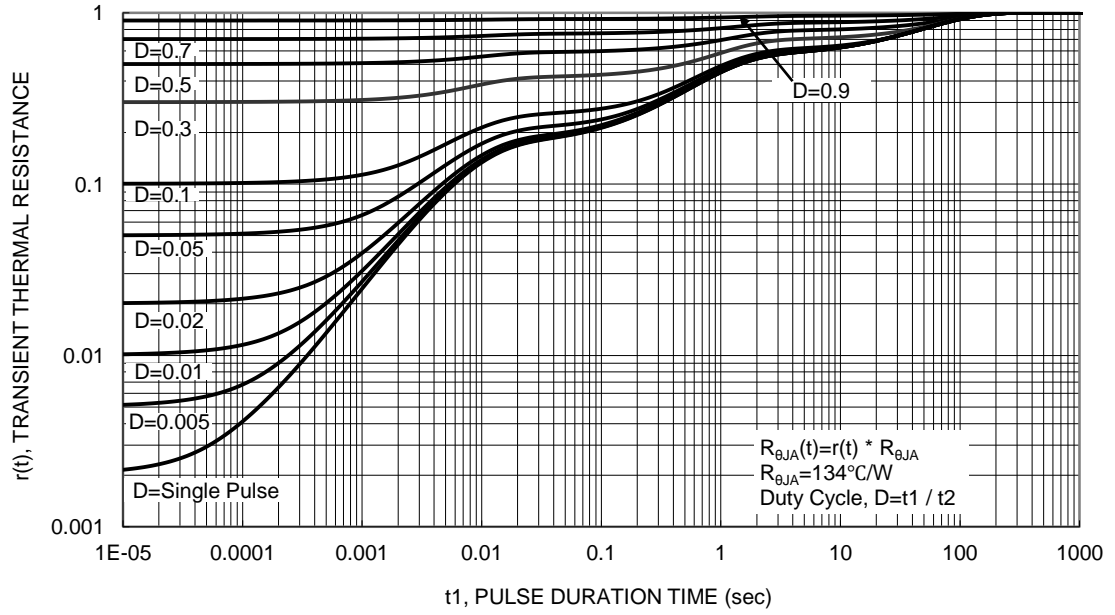

Figure 13. Transient Thermal Resistance

NEW PRODUCT

Electrical Characteristics Q2 P-CHANNEL (@ $T_A = +25^\circ\text{C}$, unless otherwise specified.)

Characteristic	Symbol	Min	Typ	Max	Unit	Test Condition
OFF CHARACTERISTICS (Note 8)						
Drain-Source Breakdown Voltage	BV_{DSS}	-60	-	-	V	$V_{GS} = 0V, I_D = -250\mu A$
Zero Gate Voltage Drain Current $T_J = +25^\circ\text{C}$	I_{DSS}	-	-	-1	μA	$V_{DS} = -60V, V_{GS} = 0V$
Gate-Source Leakage	I_{GSS}	-	-	± 100	nA	$V_{GS} = \pm 16V, V_{DS} = 0V$
ON CHARACTERISTICS (Note 8)						
Gate Threshold Voltage	$V_{GS(TH)}$	-1	-	-3	V	$V_{DS} = V_{GS}, I_D = -250\mu A$
Static Drain-Source On-Resistance	$R_{DS(ON)}$	-	115	150	m Ω	$V_{GS} = -10V, I_D = -1A$
			170	250		$V_{GS} = -4.5V, I_D = -0.5A$
Forward Transfer Admittance	$ Y_{fs} $	-	2.8	-	S	$V_{DS} = -5V, I_D = -1A$
Diode Forward Voltage	V_{SD}	-	-0.7	-1.2	V	$V_{GS} = 0V, I_S = -2A$
DYNAMIC CHARACTERISTICS (Note 9)						
Input Capacitance	C_{iss}	-	612	-	pF	$V_{DS} = -20V, V_{GS} = 0V,$ $f = 1MHz$
Output Capacitance	C_{oss}	-	36	-	pF	
Reverse Transfer Capacitance	C_{rss}	-	26	-	pF	
Gate Resistance	R_g	-	13	-	Ω	$V_{DS} = 0V, V_{GS} = 0V, f = 1MHz$
Total Gate Charge ($V_{GS} = -10V$)	Q_g	-	8.9	-	nC	$V_{DS} = -30V, I_D = -2A$
Total Gate Charge ($V_{GS} = -4.5V$)	Q_{g1}	-	4.3	-	nC	
Gate-Source Charge	Q_{gs}	-	1.4	-	nC	
Gate-Drain Charge	Q_{gd}	-	1.7	-	nC	
Turn-On Delay Time	$t_{D(ON)}$	-	7.6	-	ns	$V_{GS} = -10V, V_{DS} = -30V,$ $R_G = 50\Omega, I_D = -1A$
Turn-On Rise Time	t_R	-	11.6	-	ns	
Turn-Off Delay Time	$t_{D(OFF)}$	-	79.8	-	ns	
Turn-Off Fall Time	t_F	-	37.8	-	ns	

Notes: 8. Short duration pulse test used to minimize self-heating effect.
9. Guaranteed by design. Not subject to production testing.

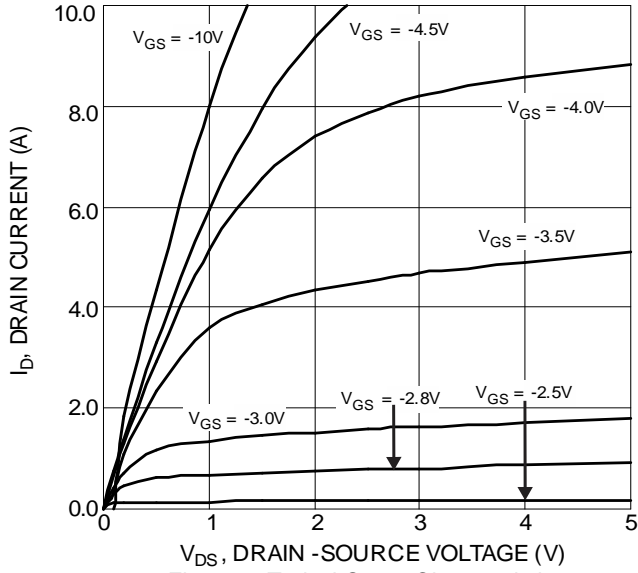

Figure 14 Typical Output Characteristics

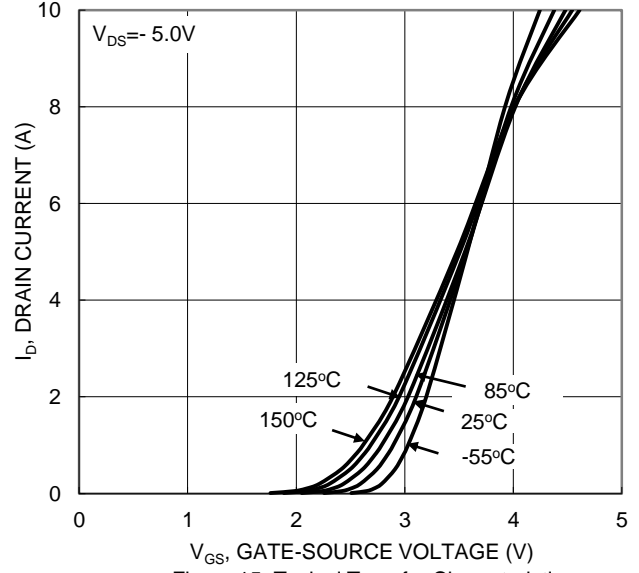

Figure 15. Typical Transfer Characteristic

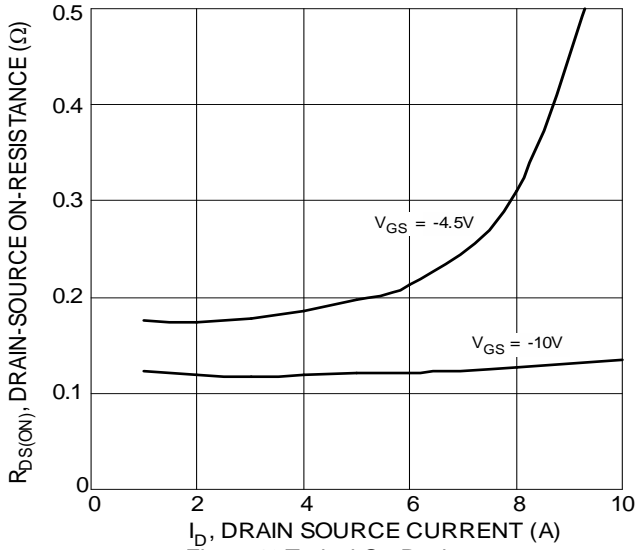

Figure 16 Typical On-Resistance vs. Drain Current and Gate Voltage

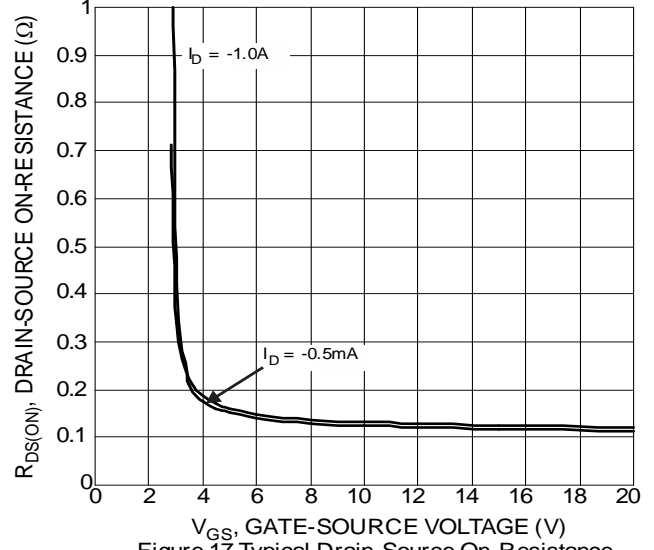

Figure 17 Typical Drain-Source On-Resistance vs. Gate-Source Voltage

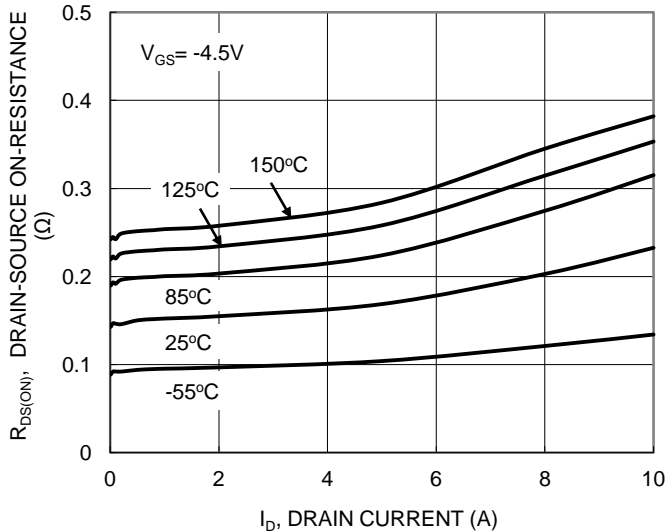

Figure 18. Typical On-Resistance vs. Drain Current and Temperature

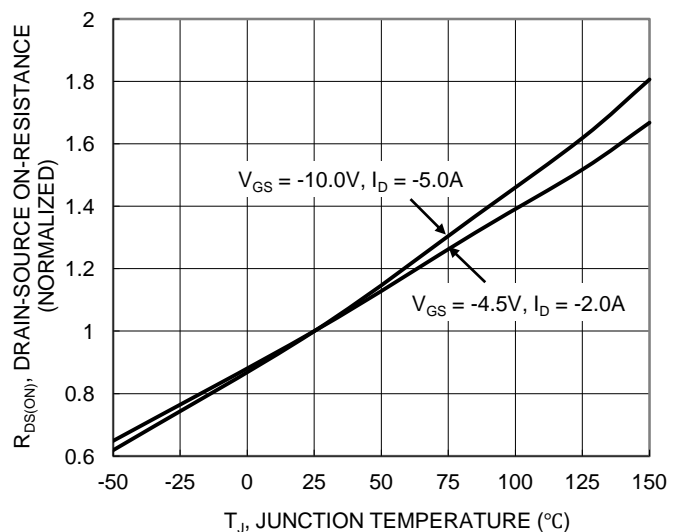
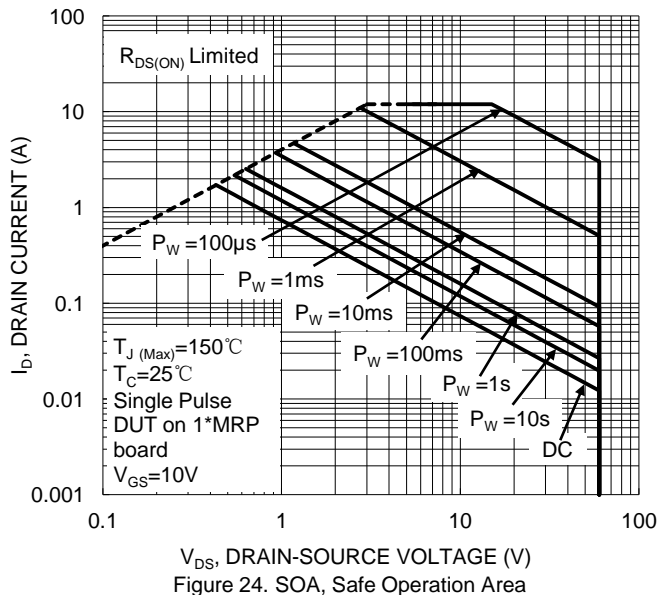
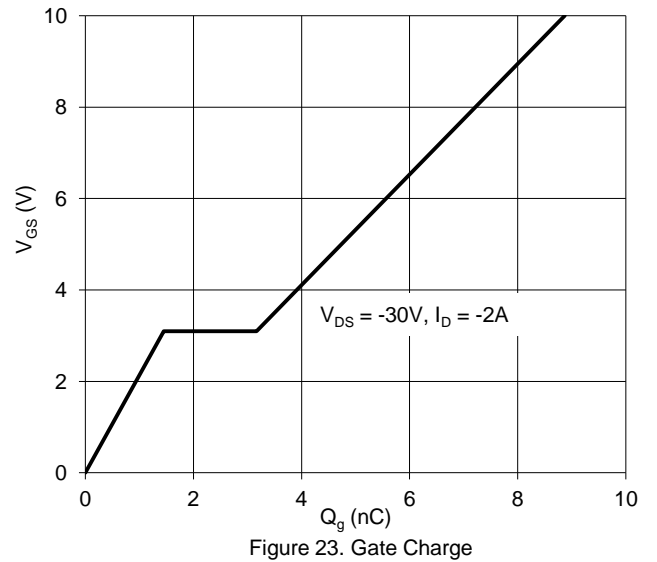
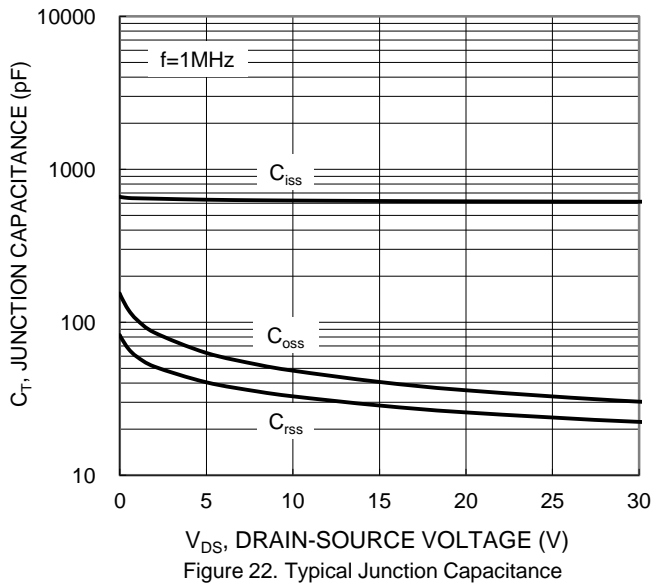
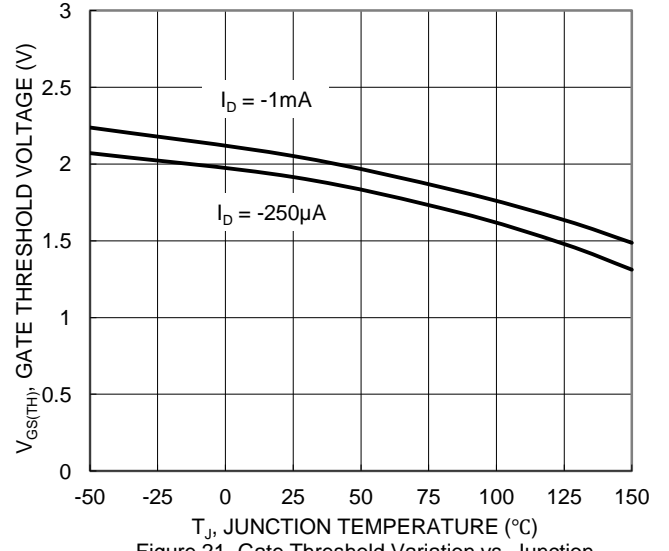
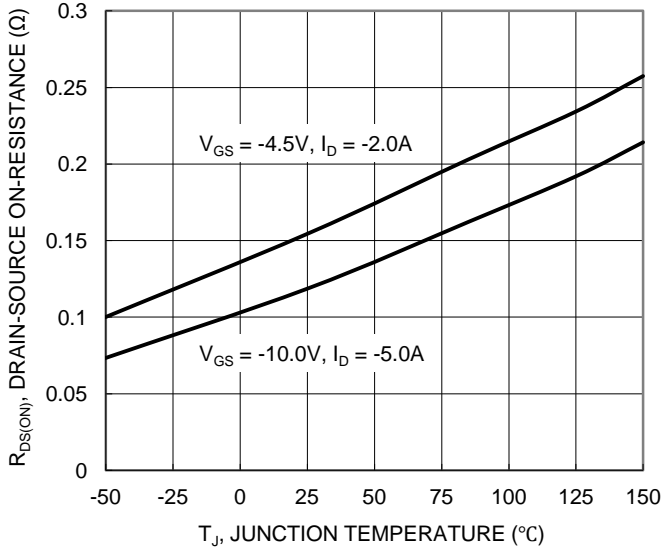
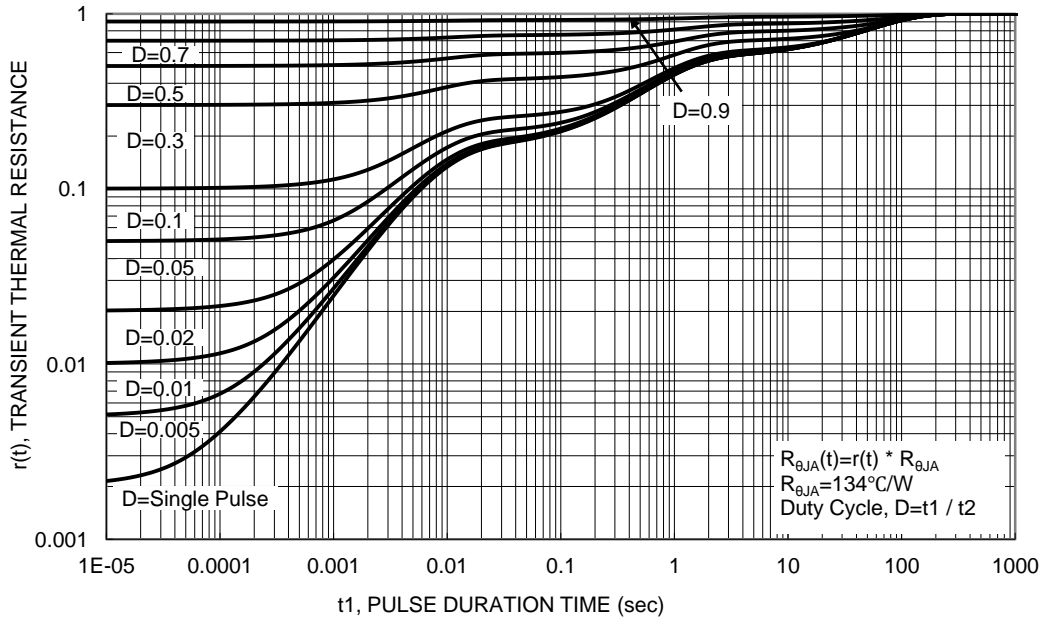

Figure 19. On-Resistance Variation with Temperature





NEW PRODUCT

Package Outline Dimensions

Please see AP02002 at <http://www.diodes.com/datasheets/ap02002.pdf> for the latest version.

**POWERDI3333-8
(Type UXB)**

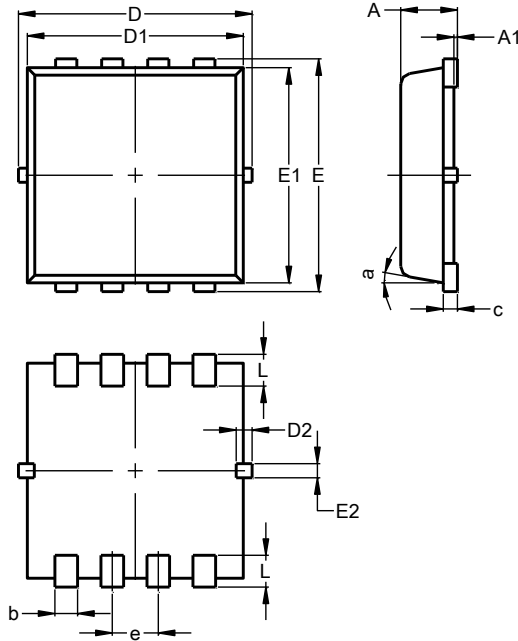

POWERDI3333-8 (Type UXB)			
Dim	Min	Max	Typ
A	0.75	0.85	0.80
A1	0.00	0.05	--
b	0.25	0.40	0.32
c	0.10	0.25	0.15
D	3.20	3.40	3.30
D1	2.95	3.15	3.05
D2	0.10	0.35	0.23
E	3.20	3.40	3.30
E1	2.95	3.15	3.05
E2	0.10	0.30	0.20
e	--	--	0.65
L	0.35	0.55	0.45
a	0°	12°	10°
All Dimensions in mm			

NEW PRODUCT

Suggested Pad Layout

Please see AP02001 at <http://www.diodes.com/datasheets/ap02001.pdf> for the latest version.

**POWERDI3333-8
(Type UXB)**

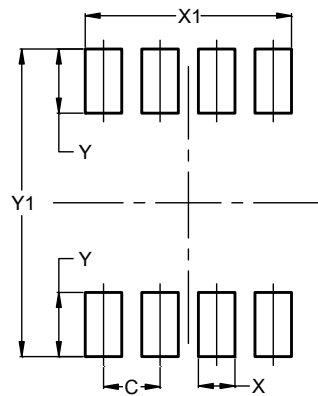

Dimensions	Value (in mm)
C	0.650
X	0.420
X1	2.370
Y	0.730
Y1	3.500

IMPORTANT NOTICE

DIODES INCORPORATED MAKES NO WARRANTY OF ANY KIND, EXPRESS OR IMPLIED, WITH REGARDS TO THIS DOCUMENT, INCLUDING, BUT NOT LIMITED TO, THE IMPLIED WARRANTIES OF MERCHANTABILITY AND FITNESS FOR A PARTICULAR PURPOSE (AND THEIR EQUIVALENTS UNDER THE LAWS OF ANY JURISDICTION).

Diodes Incorporated and its subsidiaries reserve the right to make modifications, enhancements, improvements, corrections or other changes without further notice to this document and any product described herein. Diodes Incorporated does not assume any liability arising out of the application or use of this document or any product described herein; neither does Diodes Incorporated convey any license under its patent or trademark rights, nor the rights of others. Any Customer or user of this document or products described herein in such applications shall assume all risks of such use and will agree to hold Diodes Incorporated and all the companies whose products are represented on Diodes Incorporated website, harmless against all damages.

Diodes Incorporated does not warrant or accept any liability whatsoever in respect of any products purchased through unauthorized sales channel. Should Customers purchase or use Diodes Incorporated products for any unintended or unauthorized application, Customers shall indemnify and hold Diodes Incorporated and its representatives harmless against all claims, damages, expenses, and attorney fees arising out of, directly or indirectly, any claim of personal injury or death associated with such unintended or unauthorized application.

Products described herein may be covered by one or more United States, international or foreign patents pending. Product names and markings noted herein may also be covered by one or more United States, international or foreign trademarks.

This document is written in English but may be translated into multiple languages for reference. Only the English version of this document is the final and determinative format released by Diodes Incorporated.

LIFE SUPPORT

Diodes Incorporated products are specifically not authorized for use as critical components in life support devices or systems without the express written approval of the Chief Executive Officer of Diodes Incorporated. As used herein:

A. Life support devices or systems are devices or systems which:

1. are intended to implant into the body, or
2. support or sustain life and whose failure to perform when properly used in accordance with instructions for use provided in the labeling can be reasonably expected to result in significant injury to the user.

B. A critical component is any component in a life support device or system whose failure to perform can be reasonably expected to cause the failure of the life support device or to affect its safety or effectiveness.

Customers represent that they have all necessary expertise in the safety and regulatory ramifications of their life support devices or systems, and acknowledge and agree that they are solely responsible for all legal, regulatory and safety-related requirements concerning their products and any use of Diodes Incorporated products in such safety-critical, life support devices or systems, notwithstanding any devices- or systems-related information or support that may be provided by Diodes Incorporated. Further, Customers must fully indemnify Diodes Incorporated and its representatives against any damages arising out of the use of Diodes Incorporated products in such safety-critical, life support devices or systems.

Copyright © 2015, Diodes Incorporated

www.diodes.com